

Front view



Cold location controller for installation in refrigeration units or control cabinet doors



Features

- Suitable for all cold location types, such as cold rooms and refrigeration units
- Superheating and constant temperature control in combination with separate EEV-Modul
- Connection for 3 temperature sensors (supply air, return air and limit sensor)
- Weighting of 2 control sensors
- 2nd setpoint and independent day/night changeover
- Input for door contact switch with adjustable timed cooling interruption
- Flash freezing function
- Forced air defrost, electric defrost, hot gas defrost and cool gas defrost
- Synchronised defrosting of several cold location controllers
- Defrost at fixed times or by cyclical interval
- Thermostatic fan control
- Fan control with run-up and run-down function
- Operation-dependent fan control through analogue output with adjustable speeds
- Oscillation protection and runtime monitoring
- Compressor protection activated through digital input
- 3-point control, e.g. for heating function
- Temperature control with external frequency converter (FC)
- Built-in real-time clock with power reserve
- Large data memory for temperature history
- Quick installation
- Direct connection of a CAN-USB to the service socket
- Connection to the Wurm system via Wurm CAN communication bus (C-BUS) and FRIGODATA XP

Writing conventions

 CAUTION	Avoid the described hazard: Otherwise minor or medium bodily injury or property damage will result.
 WARNING	Avoid the described hazard: Otherwise there is danger from electric voltage that can lead to death or serious bodily injury.

For your safety

For safe operation and to avoid personal injury and equipment damage through operator error, always read these instructions, become familiar with the device, and follow all safety instructions on the product and in this document, as well as the safety guidelines of Wurm GmbH & Co. KG Elektronische Systeme. Keep these instructions ready to hand for quick reference and pass them on with the device if the product is sold.

Wurm GmbH & Co. KG Elektronische Systeme accepts no liability in case of improper use or use for other than the intended purpose.

Target group	These instructions are intended for "service technicians".
Intended use	The device is installed for and serves the purpose of controlling the temperature of a cold location to an adjustable setpoint.



WARNING

Danger to life from electric shock and/or fire!



- Switch off the power to the entire plant when carrying out installation, wiring or removal work. Otherwise a mains voltage and/or external voltage may still be present even if the control voltage is switched off.
- The wiring of the device must be carried out only by qualified electricians.
- Use only the correct tools for all work.
- Check all wiring after connection.
- Take note of the maximum loads on all connections.
- Never expose the device to moisture, for example due to condensation or cleaning agents.
- Take the device out of operation if it is faulty or damaged and is therefore compromising safe operation.
- Do not open the device.
- Do not repair the device yourself. If the device requires repairs, send it in with an exact description of the fault.



CAUTION

Electromagnetic interference can cause faults!

- Always use shielded data cables and place them far away from power lines.

	Wurm Infocenter 	paperless info 
---	---	--

Version and validity of documentation

Version	Date	
V3.9.9	2022-07	Documentation status

Any versions not listed are special solutions for individual projects and are not described in detail in this document. This document automatically ceases to be valid if a new technical description is issued.

Manufacturer: Wurm GmbH & Co. KG Elektronische Systeme, Morsbachtalstraße 30, D-42857 Remscheid

For further information, see our website at www.wurm.de

Circuit diagram

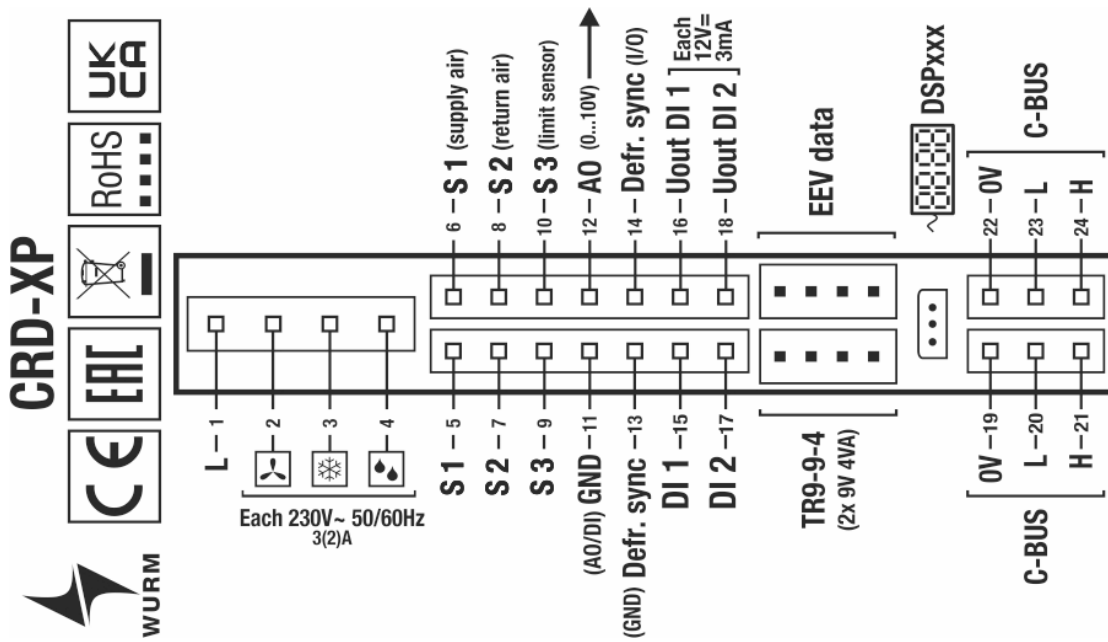

Installing

WARNING
Danger to life from electric shock and/or fire!

- Switch off the power to the entire plant before installing. Otherwise, mains voltage and/or external voltage may still be present, even if the control voltage is switched off.

Housing dimensions and installation section

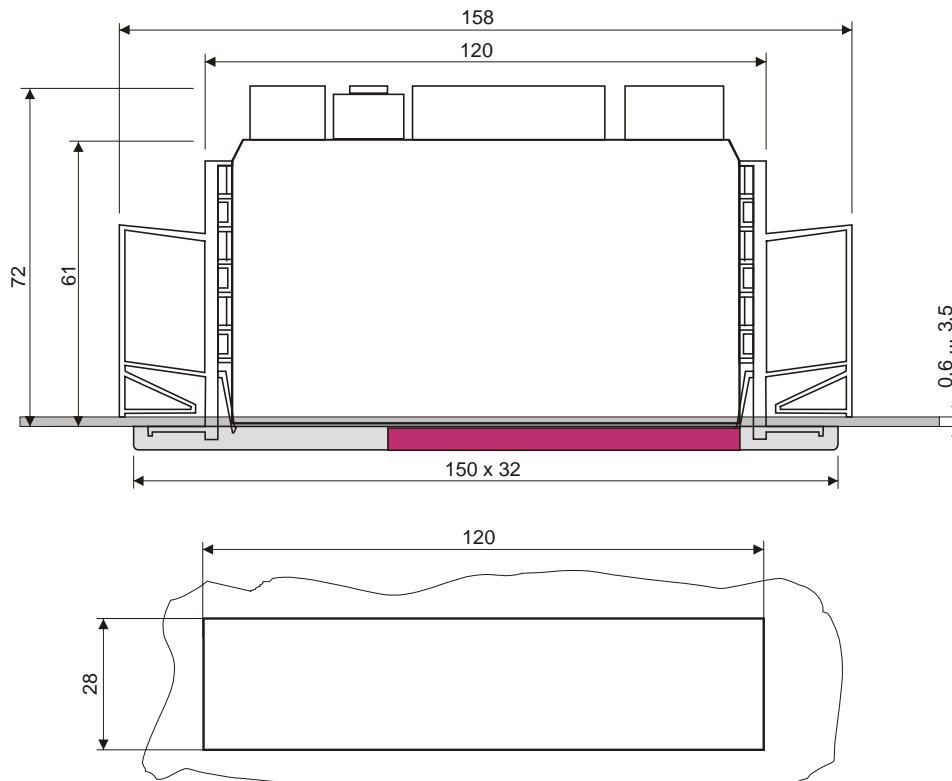

Product information

CRD-XP installation

The CRD-XP controller is installed in the refrigeration unit or control cabinet door.

1. Attach the frame clips on the left and right of the installation frame wall.
2. Connect the controller wires.
3. Place the controller on the guide rails of the frame clips and push it into the installation frame.
4. Align the sealing frame in the back of the front panel and press in firmly.
5. Place the front panel with sealing frame on the controller.
6. Press the front panel in until it is heard to engage.



Technical data

Power supply	Through transformer TR9-9-4	
Digital inputs	2 x floating (multifunction inputs)	
Temperature sensor	3 x TRK277/7 PLUS, DGF, T20015, K243	
Output relay	1 x fan, normally open contact, 230V~, 3(2)A 1 x cooling, normally open contact, 230V~, 3(2)A 1 x defrost, normally open contact, 230V~, 3(2)A The total current of these output relays must not exceed 12A.	
Communication	3-wire CAN bus interface with integrated power supply, galvanically isolated, service socket	
Communication EEV data	4-wire RS485 interface with power supply, galvanically isolated	
Analogue output	1 x 0-10V=, non-floating, short-circuit proof	
Min. load resistance	2.5kΩ / 10kΩ	
Accuracy	<3% / <1%	
Connections	Spring-loaded terminals	
Housing	Plastic	
Dimensions	(W x H x D) 158 x 32 x 75mm	
Fastening	In the installation cut-out with holding clips and sealing frame (120 x 28mm)	
Ambient temperature	Operation: 0...+55°C, storage: -25...+70°C	
Weight	About 150g	
Conformities	– 2014/30/EU (EMC Directive) – 2014/35/EU (Low Voltage Directive)	CE UK CA
EAC conformity	– TR CU 004/2011 – TR CU 020/2011	EAC
	RoHS II	
Valid from	Version 3.9.9	